

Datasheet

Nano Dimmer Air

Part No: 100212



About the product

The Loxone Nano Dimmer Air features a dimming output for line voltage lamps, for installation in an electrical box. The Touch for Nano is an optional plug-on keypad.

Electrical Data

Power supply	230 ... 240VAC, 50/60 Hz
Power consumption	typ. 400mW, max. 500mW
Power loss at max. load	5W
Output	<p>dimnable output (trailing / leading edge) Power supply: 220 ... 240VAC</p> <p>resistive load: 30 ... 200W capacitive load: 15 ... 110VA inductive load: 30 ... 200VA</p>
Interfaces	<p>Loxone Air: 868MHz (SRD Band Europe), 4 channels available max. Power 15.1mW e.r.p. 915MHz (ISM Band Region 2), 10 channels available max. Power 13.2mW internal antenna</p>
Ambient temperature	-40 ... 35°C / -40 ... 98°F
Humidity	max. 95% r.H. (non condensing)

Connections

Wire cross-section	1.0 ... 2.5mm ² / AWG18 ... 13
Stripping length	6mm / 0.23"
Temperature resistance	80°C / 176°F for IEC, 75°C / 167°F for UL
Power rating of connectors	max. 10A

Connection Diagram

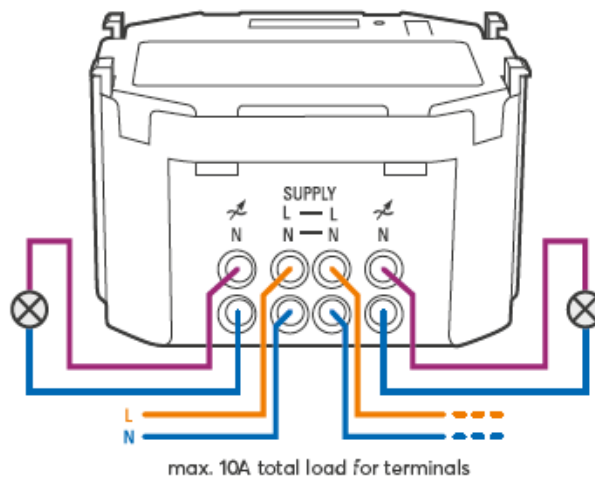
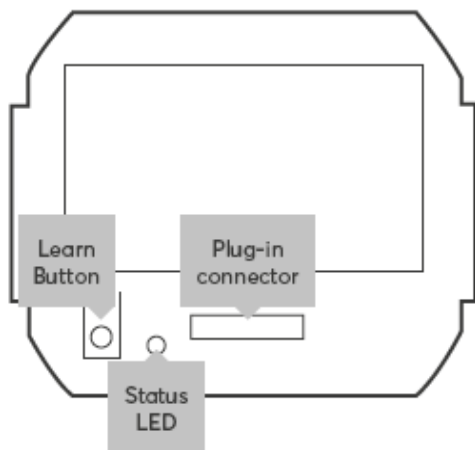

Product Characteristics

Colours	Green: RAL6018
Finish	Matte

Weight & Dimensions

Net weight	50g
Total weight	70g
Product dimensions	53x52x29 mm / 2.09x2.05x1.14" (LxWxH)

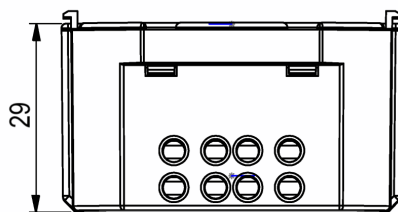
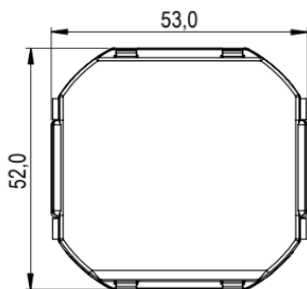

Pack size	95x88x33mm / 3.74x3.46x1.30" (LxWxH)
-----------	--------------------------------------

Certifications & Standards

Safety rating	IP20
Operation	Type 1 (EN60669-1:2009 & DIN EN 60669-2:2010)
Rated impulse voltage for outputs	1kV (max. Altitude 2000m)
Certifications	

Installation must be carried out by a qualified electrician in accordance with the relevant regulations.

Published by
Loxone Electronics GmbH

Smart Home 1
4154 Kollerschlag
Austria
Tel: +43 7287 7070-0
loxone.com

Datenblatt

Nano Dimmer Air

Art. Nr. 100212



Information zum Produkt

Der Loxone Nano Dimmer Air verfügt über einen Ausgang zur Dimmung von Hochvolt Leuchtmitteln, zur Installation in einer Unterputz oder Hohlwanddose. Optional ist das Tastenmodul Touch for Nano zum Aufstecken erhältlich.

Elektrische Daten

Spannungsversorgung	230 ... 240VAC, 50/60 Hz
Leistungsaufnahme	typ. 400mW, max. 500mW
Verlustleistung bei max. Last	5W
Ausgang	dimmbarer Ausgang (Phasenabschnitt / Phasenanschnitt) Spannungsversorgung: 220 ... 240VAC ohmsche Last: 30 ... 200W kapazitive Last: 15 ... 110VA induktive Last: 30 ... 200VA
Schnittstellen	Loxone Air: 868MHz (SRD Band Europa), 4 Kanäle wählbar max. Sendeleistung 15,1mW e.r.p. 915MHz (ISM Band Region 2), 10 Kanäle wählbar max. Sendeleistung 13,2mW interne Antenne
Umgebungstemperatur	-40 ... 35°C / -40 ... 98°F
Luftfeuchtigkeit	max. 95% r.H. (nicht kondensierend)

Anschlüsse

Leiterquerschnitt	1,0 ... 2,5mm ² / AWG18 ... 13
Abisolierlänge	6mm / 0,23"
Temperaturbeständigkeit	80°C / 176°F für IEC, 75°C / 167°F für UL
Belastbarkeit der Anschlüsse	max. 10A

Anschlussplan

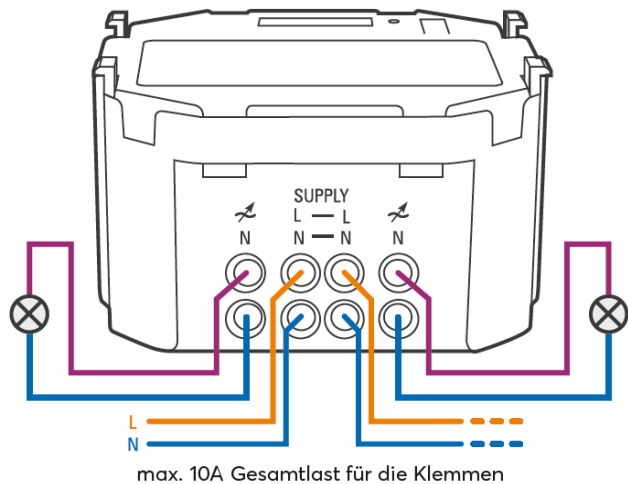
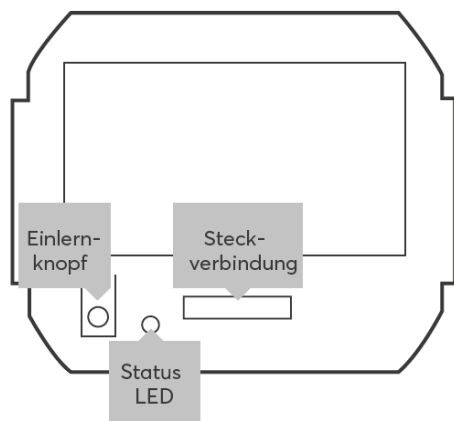

Produkteigenschaften

Farbe	Grün: RAL6018
Glanzgrad	Matt

Gewicht & Abmessungen

Nettogewicht	50g
Bruttogewicht	70g
Produktmaße	53x52x29 mm / 2,09x2,05x1,14" (LxBxH)

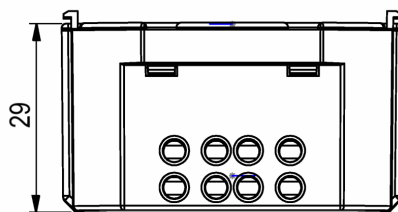
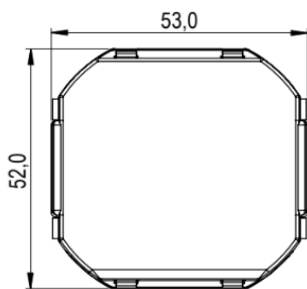

Packmaß	95x88x33mm / 3,74x3,46x1,30" (LxBxH)
---------	--------------------------------------

Zertifizierungen & Standards

Schutzart	IP20
Einsatzgebiet	Type 1 (EN60669-1:2009 & DIN EN 60669-2:2010)
Bemessungsspannung der Ausgänge	1kV (max. Altitude 2000m)
Zertifizierungen	

Die Installation muss nach den einschlägigen Vorschriften durch eine Elektrofachkraft erfolgen.

Veröffentlicht von
Loxone Electronics GmbH
Smart Home 1
4154 Kollerschlag
Austria
Tel: +43 7287 7070-0
loxone.com